

SPEAKER SYSTEMS

OWNER'S MANUAL

S0112T

S4115H

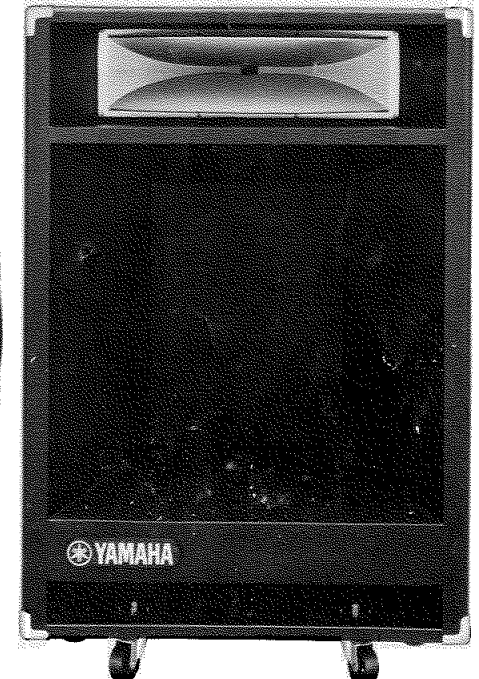
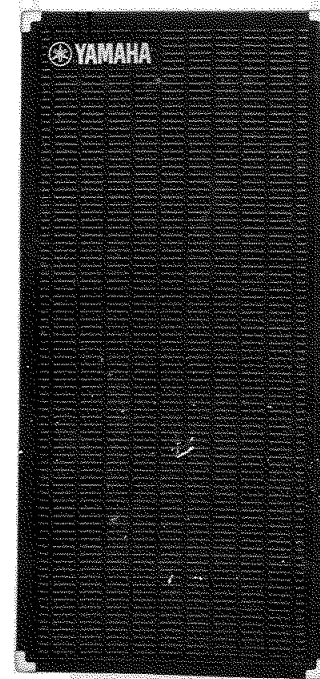

Contents	
Features	2
Precautions and Connections	3
Frequency Response & Dispersion	4
Specifications and Circuit Diagrams	5

Congratulations!

You have just joined the large and growing family of satisfied users of Yamaha products. You have chosen wisely whether you picked model S 0112T or S 4115H or both. Years of delightful sounds await you.

Please read this OWNER'S MANUAL carefully before connecting either speaker system. The few minutes spent with this manual will help you understand their operation and high performance. You will also learn how to connect the systems properly and how to really enjoy all the features Yamaha has incorporated into these two speaker systems.

If you need any special help or service, see your Yamaha dealer. He knows what to do and will be happy to help you. You've made a good choice. We wish you years of happy listening.

FEATURES

Yamaha presents two high efficiency, reliable speaker systems incorporating our famous sound technology. We think you'll enjoy the sounds and power that are possible with these systems when you use them as part of your PA system. Model S 0112T highlights vocal punch styled tonal quality while Model S 4115H features strong carrying power for clear and well-defined sound.

High efficiency speakers

Model S 0112T uses one 12" and one 10" woofer, recently developed and manufactured by Yamaha, combined with 4 tweeters. Model S 4115H employs Yamaha's recently developed high frequency driver and horn and the special 15" woofer. Both systems show excellent directional dispersion.

Big power

Continuous program power rating of 80 Watts (S 0112T) and 100 Watts (S 4115H) for plenty of power.

Solid enclosure

Design takes in the total system so that there is a perfect match between speakers and enclosure. Sturdy, solid bass reflex enclosure (S 0112T) and front loaded and bass reflex enclosure (S 4115H) offer tonal fidelity and a full rich sound.

Broad frequency response

A wide frequency response from 70Hz to 13KHz (S 0112T) or from 70Hz to 15KHz (S 4115H).

Detachable castors

Model S 4115H also has detachable castors that can be easily taken off or put on. Handling problems are simplified.

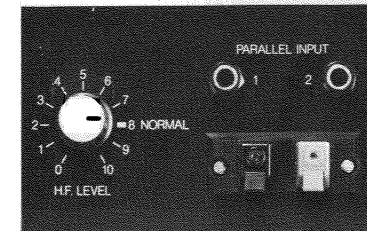

H.F. Level Control

Model S 4115H comes with a High Frequency Level Control that permits continuous control of the high/midrange horn speaker output. If this control is set at 0, the high/midrange (above 2KHz) horn speaker is cut. Normal setting is 8 (NORMAL).

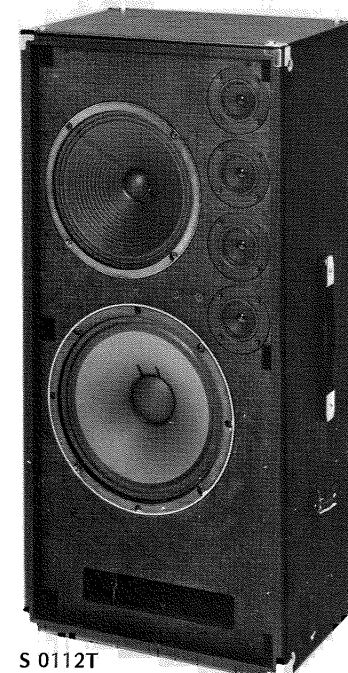
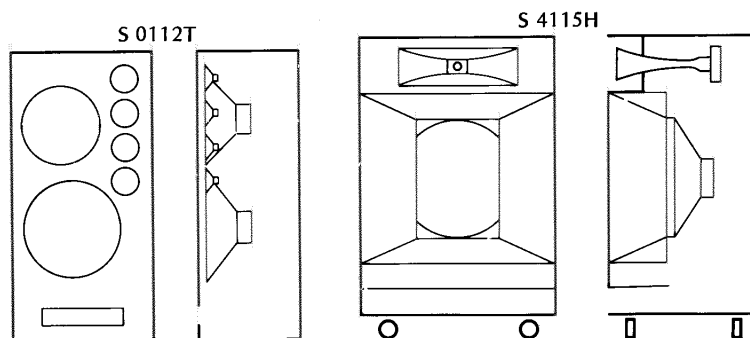

S 0112T

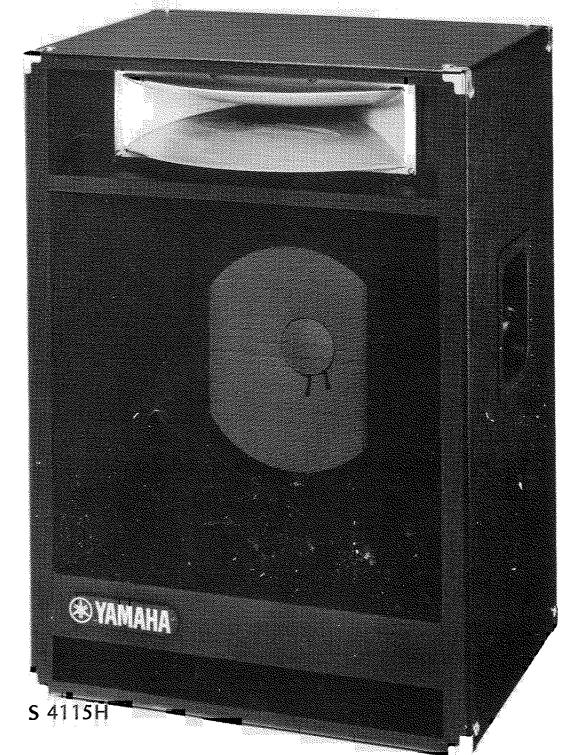

S 4115H

PRECAUTIONS & CONNECTIONS

Precautions

Both speaker systems, S 0112T and S 4115H, are high efficiency units. They will give you years of faithful service if used properly. The most frequent cause of trouble is improper use. Read these instructions carefully before connecting either speaker system.

1. Turn off your amplifier before connecting the speaker system.
2. S 0112T has a power rating of 80 Watts (continuous program) and S 4115H is rated at 100 Watts (continuous program). Should either speaker system be driven beyond its power rating, two problems may occur: 1) the speaker voice coil may be damaged; 2) sound will be distorted.
3. System impedance of both the S 0112T and S 4115H is 8 ohms. For maximum efficiency, power handling ability and minimum distortion the output impedance of your amplifier should match these speaker systems. If the impedances do not match two problems may occur: 1) power loss because only a part of the amplifier's rated power can be delivered to the speaker systems; 2) distortion caused by the load applied to the amplifier.
If two speaker systems are connected to your amplifier in parallel check carefully that the impedances match since with this type of connection the impedance of the total system is reduced.

4. Match the polarity ($\oplus \cdot \ominus$) of the amplifier and speaker system when using the S 4115H speaker terminals. If they are connected in reverse the speaker system will not perform as it was designed.

Connecting Up

1. Connecting to PA mixer with built-in power amplifier. For example: Yamaha EM-150

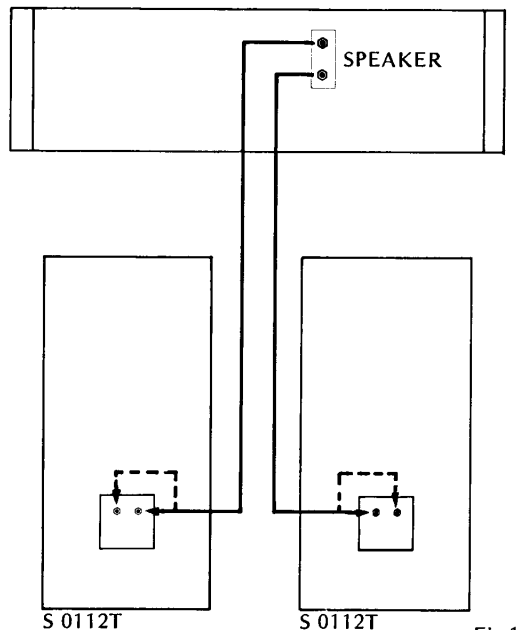

Fig.1

To EM-150 SPEAKER output jacks

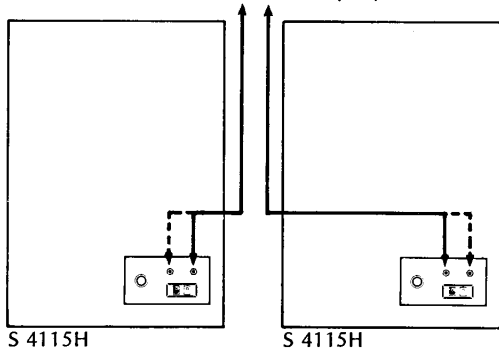

Fig.2

Connect the speaker systems and amplifier with the attached speaker cords as shown in Fig.1, 2. Connect the cords to either the place shown by the solid or dotted line.

2. Connecting to an ordinary power amplifier. For example: Yamaha P-2200

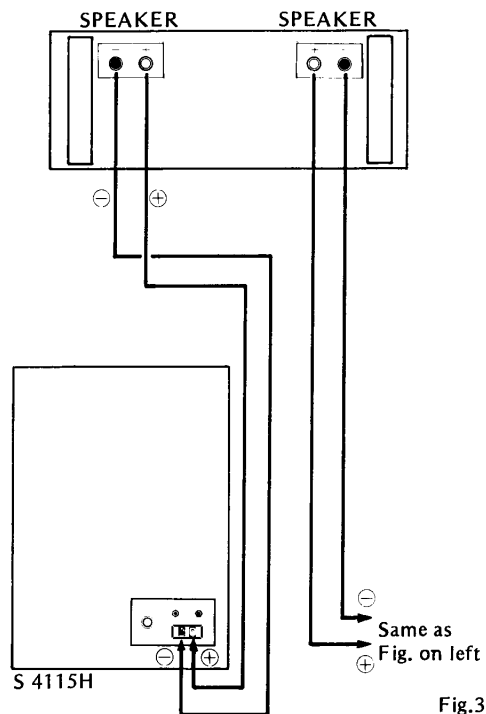

Fig.3

Fig.3 shows the method of connection when both the speaker system and amplifier have terminal connectors. It's the same with both S 0112T and S 4115H when connecting to the phone jacks. For this case look at Fig.4 which shows the the polarity ($\oplus \cdot \ominus$) inside the plug of the speaker system.

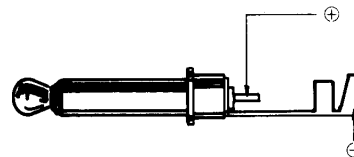

Fig.4

FREQUENCY RESPONSE & DISPERSION

3. Parallel connection of speaker systems

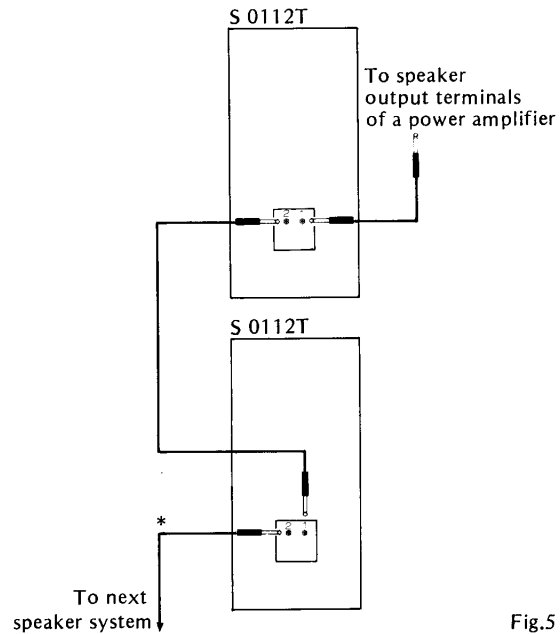

Fig.5

Both the S 0112T and S 4115H can be connected in parallel as shown in the Fig.5. Namely, ordinary power amplifiers are designed to operate stably at a speaker system load impedance of 4 ohms or 8 ohms. Except in such a special case* as a power amp that operates stably with a load impedance below 4 ohms, don't connect more than two speaker systems in parallel. This may damage the power amplifier and speakers.

4. Connecting to speaker terminals (S 4115H)

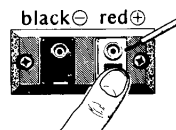
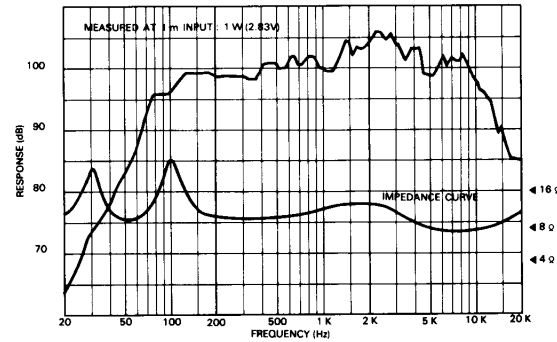

Fig.6

With your finger press the bottom part of the terminal as shown in the Fig.6, insert the speaker cord, take your finger away and the cord is locked in place.

S 0112T FREQUENCY RESPONSE



S 0112T HORIZONTAL 180° DISPERSION

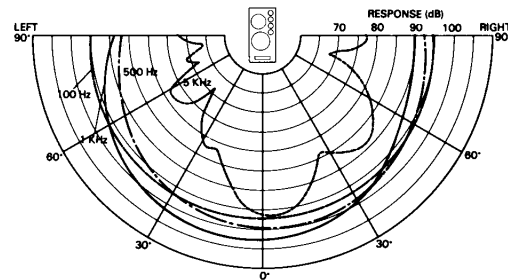

S 0112T VERTICAL 180° DISPERSION

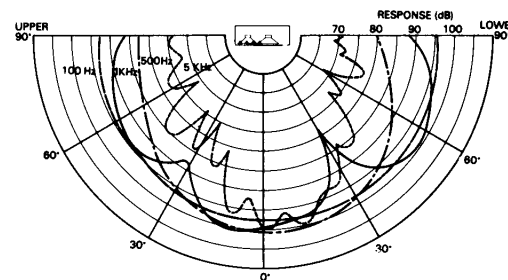

S 4115H FREQUENCY RESPONSE

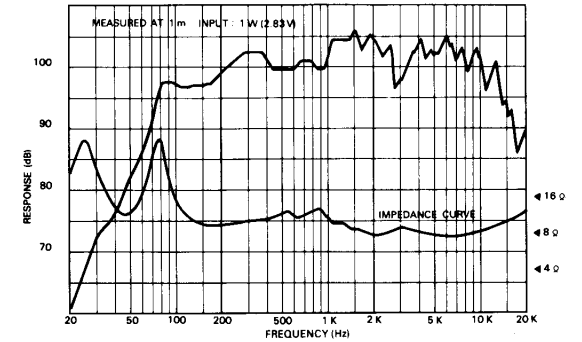

S 4115H HORIZONTAL 180° DISPERSION

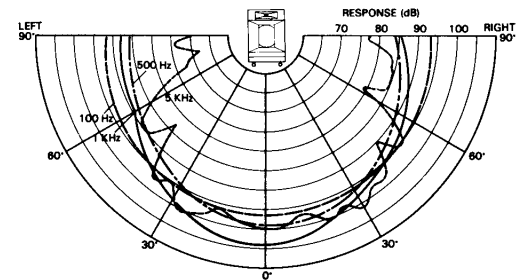

S 4115H VERTICAL 180° DISPERSION

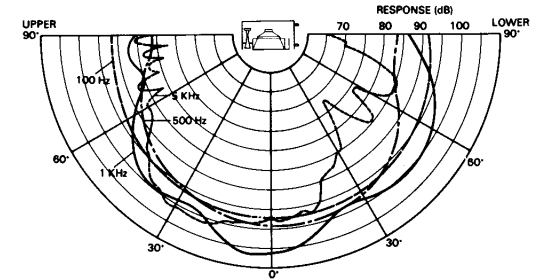

SPECIFICATIONS & CIRCUIT DIAGRAMS

Model	S 0112T	S 4115H
Power Rating ¹ Continuous Program	80W	100W
Frequency Range	70Hz ~ 13KHz (98 ± 6dB)	70Hz ~ 15KHz (101 ± 6dB)
Nominal Impedance	8Ω	8Ω
Sensitivity ²	A: 98dB B: 49dB	A: 101dB B: 52dB
Crossover Frequency	4.5 KHz (12dB/OCT)	2KHz (12dB/OCT)
Speakers	Woofer: JA3061x1 Woofer: JA2507x1 Tweeter: JA0554x4	Woofer: JA3803x1 H.F. Driver & Horn: JA4201x1
Dispersion	Horizontal: 100°, Vertical: 50° (6dB down points at 1KHz)	Horizontal: 70°, Vertical: 40° (6dB down points at 1KHz)
Enclosure	Bass Reflex	Front Loaded and Bass Reflex
Dimensions ³ (W x D x H)	435 x 326 x 910mm* (17-1/8 x 12-7/8 x 35-7/8")	610 x 452 x 838mm** (24 x 17-3/4 x 33")
Net Weight	29Kg (63.9lbs.)	54Kg (119lbs.)
Finish	Black Leatherette	Black Leatherette

¹ May be used with amplifiers having up to equal continuous RMS power rating.

² A: The SPL achieved at 1m with 1 Watt input.

B: The SPL achieved at 30 feet with a 1 milliwatt input.

³ *Height including slip fitting. **Height not including castors.

LOUDSPEAKER SPECIFICATIONS

Model	JA3061	JA2507	JA0554	JA3803	JA4201
Cone Diameter	12" (30cm)	10" (25cm)	2" (5cm)	15" (38cm)	1-5/8" (4.2cm)
Nominal Impedance	16Ω	16Ω	8Ω	8Ω	8Ω
Continuous Pink Noise Power Rating (Rated Power Bandwidth)	40W	40W	3W	120W	20W
Flux Density	12,000 Gauss	12,000 Gauss	10,700 Gauss	12,500 Gauss	16,000 Gauss

